

 CHECK VALVE zCHE



Body material	Nominal pressure	Nominal diameter	Max. temperature
A Grey cast iron	C 16 bar	DN 40-250	100°C**
	B 10 bar	DN 300-600*	

* on request





** Maximum temporary working temperature 100°C

 correspond to the pressure equipment directive 2014/68/UE marking CE for DN≥65

FEATURES

- compact settlement
- environment-friendly
- no maintenance
- allows installation in all positions

APPLICATION

industries			
	SHIPBUILDING INDUSTRY	HEATING	
media			
	GLYCOL	INDUSTRIAL WATER	NEUTRAL FLUIDS

Data given can be changed without notice.

Edition 01/2018

FIG.407

MATERIALS, DIMENSIONS

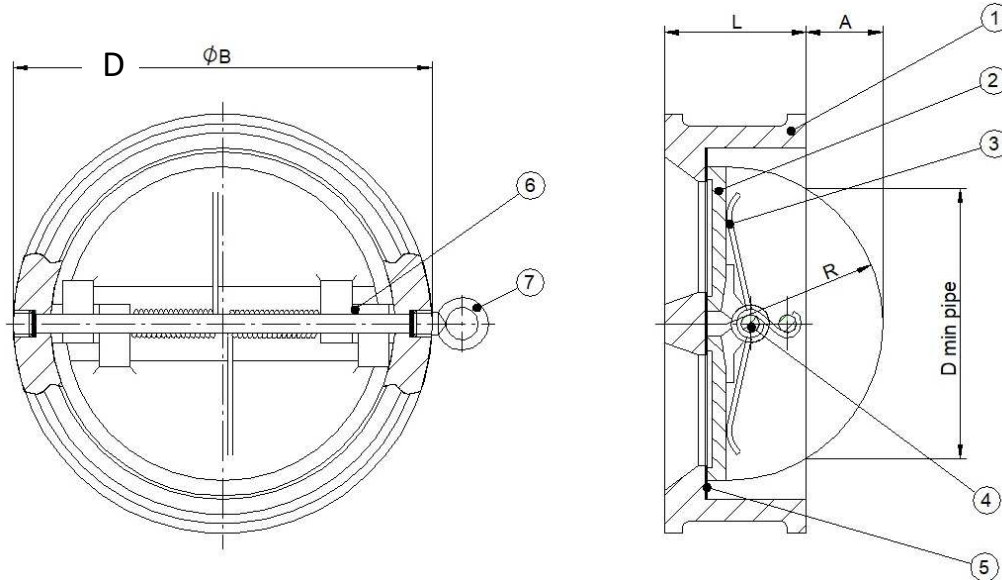

	Body material	A	
	Type	54	56
1	Body	EN-GJL-250 5.1301 (ex.JL1040)	
2	Plate	X5CrNi18-10 1.4301	EN-GJS-400-15 5.3106 (ex.JS1030) nickel
3	Spring	X5CrNi18-10 1.4301	
4	Pin	X5CrNi18-10 1.4301	
5	Seal	EPDM	
6	Sleeve	Teflon	
7	Sling for DN125 - 600	S235JR	
Max. temperature		100°C	

DN	40	50	65	80	100	125	150	200	250	300	350	400	500	600
D min pipe (mm)	36	42	60	66	86	115	143	197	231	281	330	378	464	567
L (mm)	43	43	46	64	64	70	76	89	114	114	127	140	152	178
A (mm)	6,8	8,6	15,2	14,3	22,3	33,7	45,4	69,6	74,5	102,7	124,7	142,7	179,7	217,4
D (mm)	91	107	127	142	162	192	218	273	328	378	437	489	594	695
R (mm)	25,8	27	35	42	50	64	77	102,5	125	146	170	195	238	292
K_{vs} (m ³ /h)	34	34	54	95	200	320	467	990	1584	2783	3689	6076	11563	19919
Weight (kg)	1,2	1,5	2,3	3,6	4,35	6,0	8,6	15,2	24	35,2	58	71	125	170

Data given can be changed without notice.

Edition 01/2018

ZETKAMA Sp. z o.o.
Ul. 3 Maja 12
PL 57-410 Ścinawka Średnia

Tel. +48 74 8652 193
Tel. +48 74 8652 111
Fax +48 74 8652 199

E-mail export@zetkama.com.pl
www.zetkama.com

HYDRAULIC CHARACTERISTICS

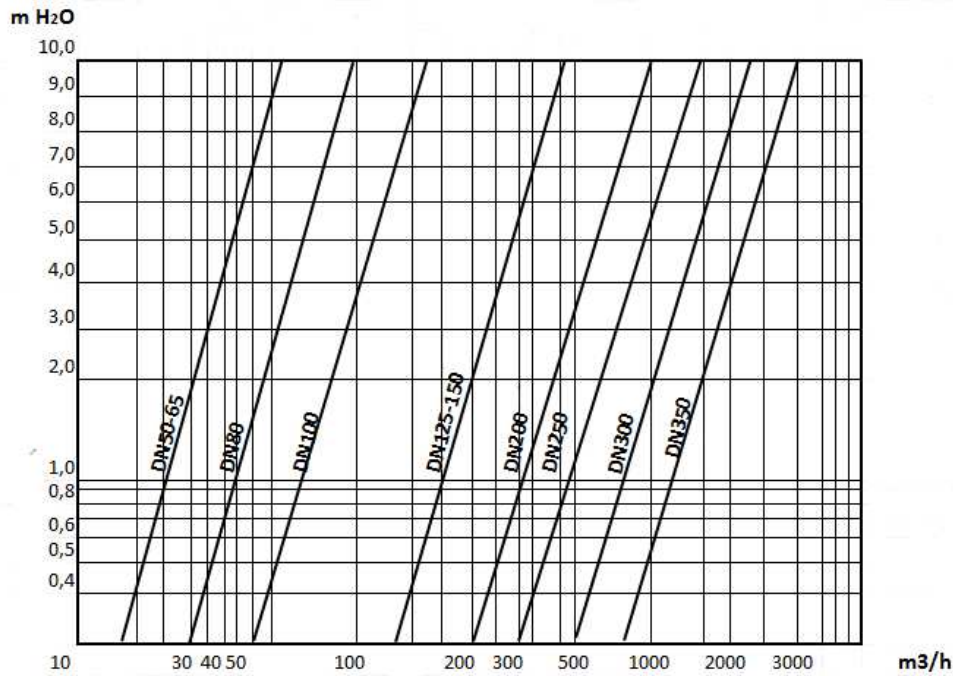

TYPE

Figure	Body material	Nominal diameter	Nominal pressure	Type
407	A Grey cast iron EN-GJL-250	40-250 mm	C 16 bar	54 closing EPDM / stainless steel; epoxy painted; plate stainless steel
		300-600 mm	B 10 bar	54 closing EPDM / stainless steel; epoxy painted; plate stainless steel
		40-250 mm	C 16 bar	56 closing EPDM / cast iron; epoxy painted; plate – cast iron nickel
		300-600 mm	B 10 bar	56 closing EPDM / cast iron; epoxy painted; plate – cast iron nickel

Data given can be changed without notice.

Edition 01/2018

ORDERING

Figure	Body material	Nominal diameter	Nominal pressure	Type
407	A Grey cast iron EN-GJL-250	300-600 mm	B 10 bar	56 closing EPDM / cast iron; epoxy painted; plate – cast iron nickel

Order example acc. index

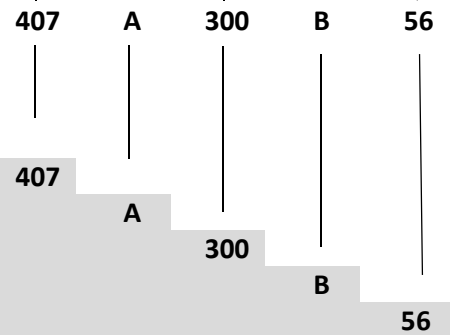

- Check valve, ends wafer type, form straight
- Grey cast iron EN-GJL-250
- Nominal diameter (mm)
- Nominal pressure PN 10
- Closing EPDM / cast iron; epoxy painted; plate – cast iron nickel

Data given can be changed without notice.

Edition 01/2018