



FMCW Radar Level Transmitter



PRODUCT INTRODUCTION

FMCW Radar level transmitter is a non contact measuring device, which is suitable for high temp., high pressure, and corrosive applications. It is easy to install and free of maintenance, especially for the high accuracy requirement environment.

PRINCIPLE

FMCW radar adopts a high frequency signal, which is emitted via an antenna and swipes frequency increment by 0.5GHz during the measurement, reflected by the target surface and received at a time delay. The frequency difference, which is calculated from the transmitting frequency and the received frequency, which is directly proportional to the measured distance (or material surface).

The frequency difference then is processed by Fast Fourier Transformation (FFT) to identify the signal in Intermedium Frequency (IF). This FMCW radar is innate with signal / noise enhancement and filtering of echo-back via Phase-Lock Loop (PLL) circuit that is the best solution for complex environment and high accuracy measurement.

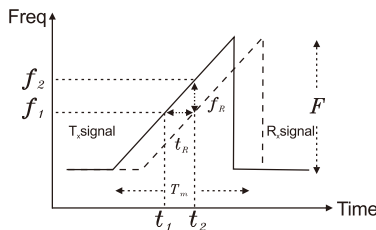

Design formula

$$\text{Slop} = \frac{F}{T_m} = \frac{f_R}{t_r} = \frac{f_R}{\frac{2R}{c}} \quad t_r = \frac{2R}{c}$$

$$R = \frac{F_R \times c \times T_m}{2F}$$

LINEARITY DIAGRAM

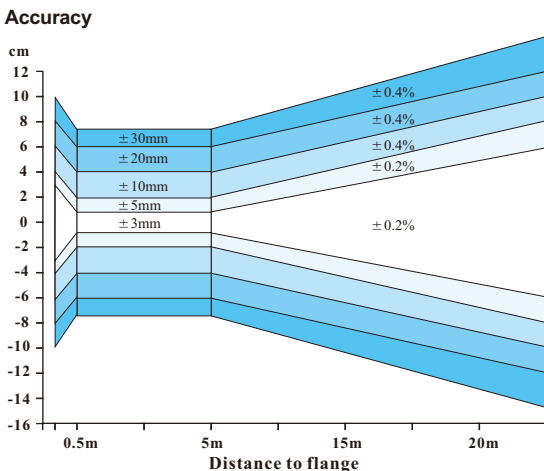

FEATURES

- Non contact measuring
- Corrosive and toxic liquid, hydrocarbons, slurries
- Not affected by specific gravity, pressure, temperature, viscosity, foam, and dust
- 5 digits LCM display
- Indicate signal wave inside the silo.
- Selection of Different Measurement unit(m, cm, mm, inch, Ft, %, mA)
- Measuring distance and actual level.
- Language selection of traditional Chinese, simplified Chinese, English.
- 4-20mA / 4 wires / 2 wires
- Modbus RS-485 to enhance isolation and easy for remote control.
- CE standards for isolation(EFT 2000V, B class or better)
- Suitable for mid-range signal
- 4mA, 20mA output
- Isolated circuit design.
- 26GHz JFR2 series could measure all kinds of material.

TEST STANDARDS

- High voltage : IEC60947-2
- Isolated resistance : IEC60092-504
- Power supply change : IEC60092-504
- Power supply failure : IEC60092-504
- Electrical burst testing : IEC61000-4-4
- Voltage DIPS : IEC61000-4-11
- Humidity : IEC60068-2-30
- High/Low temperature test : IEC60068-2-38
- IP protection rating : IEC60529

SPECIFICATION (26GHz 4-wire)

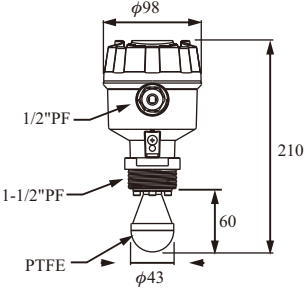
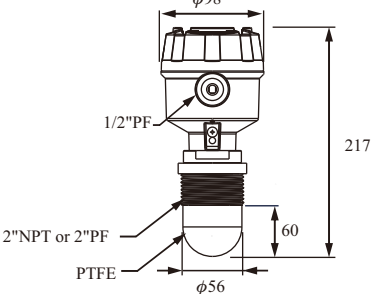
Dimensions (Unit:mm)		
Model	JFR-204	JFR-214
Medium	General liquid and solid	General liquid /suitable for acid and alkaline in liquid
Min. Dielectric constant (solid)	1.5	
Min. Dielectric constant (liquid)	1.4	
Measuring range	Liquid 30m Solid 20m	Liquid 30m
Accuracy	± 3 mm	
Repeatability	± 1 mm	
Digital communication	RS485 (Isolated)	
Ambient temperature	-40~90 °C(LCM<75°C)	
Operating temperature	-40~200 °C	
Operating pressure	0~40 bar	
Frequency	K Band	
Analog output	4~20mA / 4 Wire	
Protection rating	IP67	
Power supply	9.5~30Vdc	
Local display	5 digits LCM display	
Housing material	Aluminum	
Antenna type	Horn (43D)	Lens (56D)
Half-power beam width	$\pm 9^\circ$	
Antenna material	SUS316+PTFE	PTFE
Blind distance	500mm	

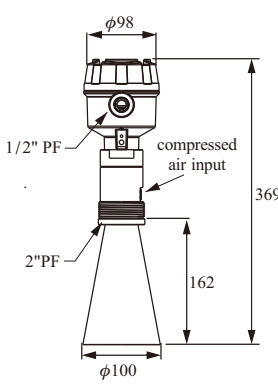
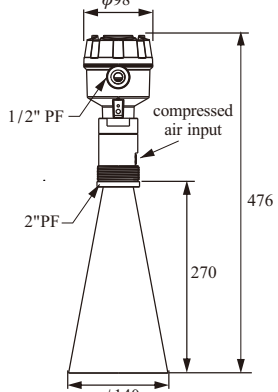
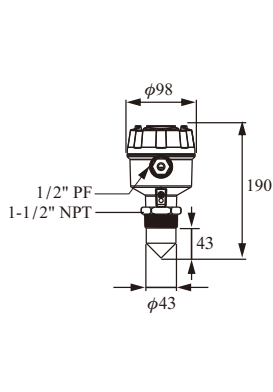
Dimensions (Unit:mm)			
Model	JFR-224	JFR-234	JFR-244
Medium	General liquid and solid		
Suitable For	Long distance measurement	Super distance measurement	Corrosion type acid and alkaline liquid
Min. Dielectric constant (solid)	1.5		
Min. Dielectric constant (liquid)	1.4		
Measuring range	Liquid 40m Solid 30m	Liquid 70m Solid 50m	Liquid 20m Solid 15m
Accuracy	± 3 mm	± 3mm @distance<40m ± 0.01%F.S. @distance>40m	± 3 mm
Repeatability	± 1 mm		
Digital communication	RS485 (Isolated)		
Ambient temperature	-40~90 °C(LCM<75°C)		
Operating temperature	-40~200 °C		
Operating pressure	0~40 bar		
Frequency	K Band		
Analog output	4~20mA / 4 Wire		
Protection rating	IP67		
Power supply	9.5~30 Vdc		
Local display	5 digits LCM display		
Housing material	Aluminum		
Antenna type	High gain horn (100)	High gain horn (140)	Lens(43DS)
Half-power beam width	± 5°	± 3°	± 10°
Antenna material	SUS 316		PTFE
Blind distance	500 mm		

P.S. For JFR-224 and JFR-234, customer can connect the compressed air with 1/8"PT thread connector to avoid dust adhered.

SPECIFICATION (26GHz 2-wire)

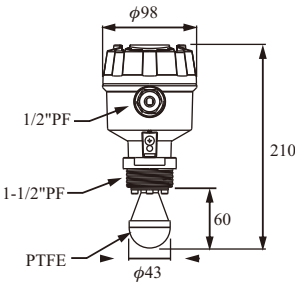
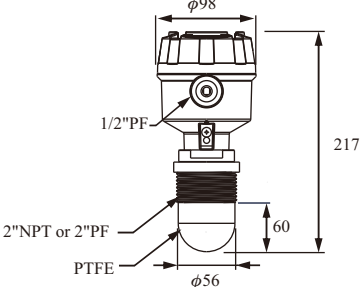
Dimensions (Unit:mm)		
Model	JFR-202	JFR-212
Medium	General liquid and solid	General liquid /suitable for acid and alkaline in liquid
Min. Dielectric constant (solid)	1.5	
Min. Dielectric constant (liquid)	1.4	
Measuring range	Liquid 20m Solid 10m	Liquid 20m
Accuracy	± 5mm	
Repeatability	± 3mm	
Digital communication	HART	
Ambient temperature	-40~90°C(LCM<75°C)	
Operating temperature	-40~200°C	
Operating pressure	0~40 bar	
Frequency	K Band	
Analog output	4~20mA	
Protection rating	IP67	
Power supply	24Vdc ± 10%	
Local display	5 digits LCM display	
Housing material	Aluminum	
Antenna type	Horn (43D)	Lens (56D)
Half-power beam width	±9°	
Antenna material	SUS 316 + PTFE	PTFE
Blind distance	500 mm	

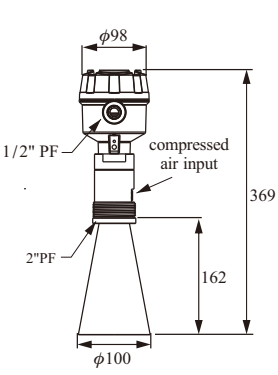
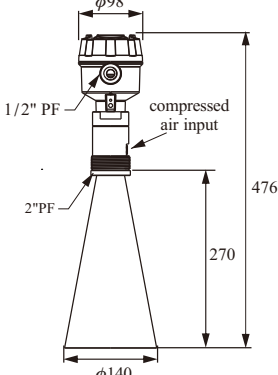
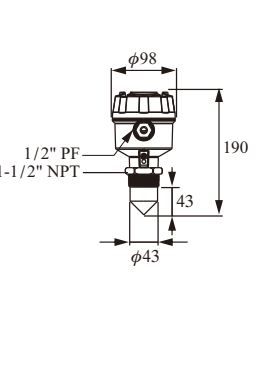
Dimensions (Unit:mm)			
	Model	JFR-222	JFR-232
Medium	General liquid and solid		
Suitable For	Long distance measurement	Super distance measurement	Corrosion type acid and alkaline liquid
Min. Dielectric constant (solid)	1.5		
Min. Dielectric constant (liquid)	1.4		
Measuring range	Liquid 30m Solid 20m	Liquid 35m Solid 30m	Liquid 15m
Accuracy	± 5 mm	± 3mm @distance<40m ± 0.01%F.S. @distance>40m	± 5 mm
Repeatability	± 3mm		
Digital communication	HART		
Ambient temperature	-40~90°C(LCM<75°C)		
Operating temperature	-40~200°C		
Operating pressure	0~40 bar		
Frequency	K Band		
Analog output	4~20mA		
Protection rating	IP67		
Power supply	24Vdc ± 10%		
Local display	5 digits LCM display		
Housing material	Aluminum		
Antenna type	High gain horn (100D)	High gain horn (140D)	Lens (43DS)
Half-power beam width	±5°	±3°	±10°
Antenna material	SUS 316		PTFE
Blind distance	500 mm		

P.s. For JFR-222 and JFR-232, customer can connect the compressed air with 1/8"PT thread connector to avoid dust adhered.

WIRING/CALIBRATION

WIRING INFORMATION

RS485 wiring

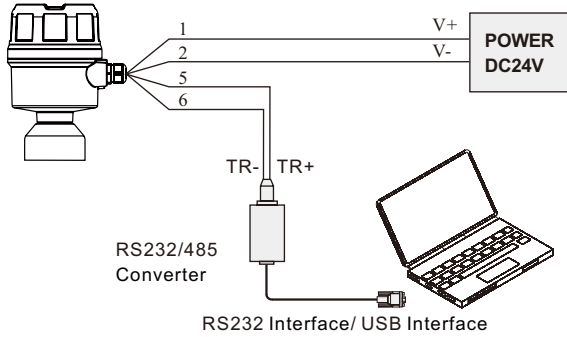

JFR Series and Indicator(External Power)

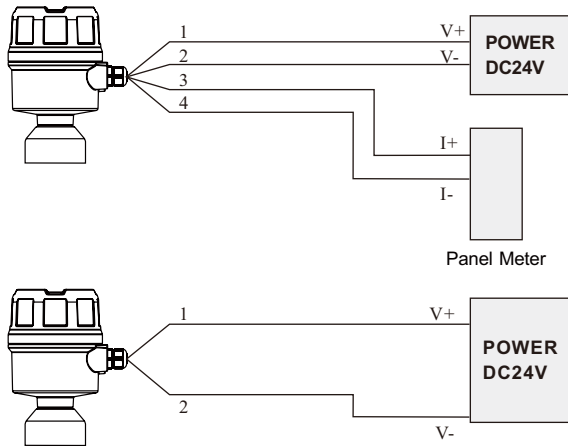

WIRING DIAGRAM

JFR-2X4

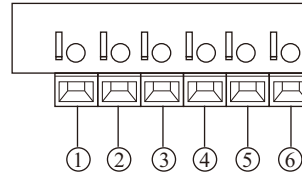

JFR-2X2

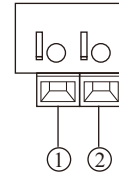

- ① Power Supply: V+
- ② Power Supply: V-
- ③ Analog Output: I+ (4~20mA)
- ④ Analog Output: I- (4~20mA)
- ⑤ Communication: TR+ (RS485)
- ⑥ Communication: TR- (RS485)

CALIBRATION

Two ways to calibrate the JFR Series:

4-wire:

1. Display/Adjustment module
2. By pcbased fas soft ware

2-wire:

1. Display/Adjustment module
2. HART

Adjustment module is an adjustment tool with 4 buttons to click on. It also has a transparent window to allow display reading.

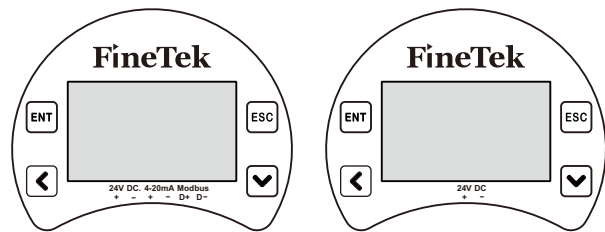

5 digits LCM display

[ENT] Button

- Enter Edit status
- Confirm Edit
- Confirm parameter modification

[←] Button

- Select Edit
- Select parameter
- Parameter

[ESC] Button

- Return
- Cancel

[▼] Button

- Increase
- Select

INSTALLATION

1. JFR-20x can be hidden in the extension tube, the recommendation of the tube diameter D and length L are shown in the table.

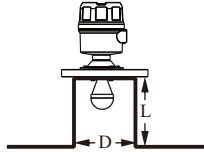

Diameter D (Inch)	Length L (Inch)
2"	$L \leq 160$
4"	$L \leq 300$
5"	$L \leq 400$
6"	$L \leq 500$

2. JFR-21x can be hidden in the extension tube, the recommendation of the tube diameter D and length L are shown in the table.

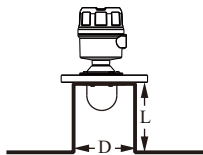

Diameter D (Inch)	Length L (Inch)
3"	$L \leq 200$
4"	$L \leq 300$
5"	$L \leq 400$

3. JFR-22X and JFR-23X can be hidden in the extension tube, the recommendation of the tube diameter D and length L are shown in the table.

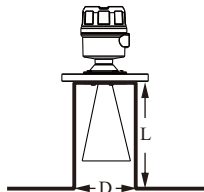

Model	Diameter D (Inch)	Length L (Inch)
JFR-22X	$D > 100$	$L \leq 150$
JFR-23X	$D > 140$	$L \leq 270$

4. JFR-24x can be hidden in the extension tube, the recommendation of the tube diameter D and length L are shown in the table.

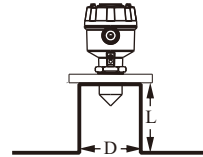

Diameter D (Inch)	Length L (Inch)
2"	$L \leq 100$
4"	$L \leq 200$
5"	$L \leq 300$
6"	$L \leq 400$

5. Installation recommendations are as follows :
- (1) Antenna installation angle to be perpendicular to the Horizontal.
 - (2) JFR installation position with the drum wall suggestions Are as follows :
Installation location A should be less than $1/6D$
Range with A relation is as follows :
a. $H < 10m$, $A > 300mm$
b. $10m < H < 20m$, $A > 600mm$
c. $H > 20m$, $A > 900mm$

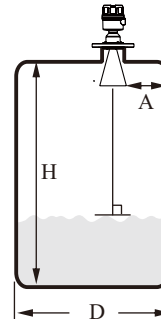

- (3) Extended tube is suggested to do the welding process from outside; welding process from inside, the bulges might affect the signal transmission. The joint part of extended tube cannot be less than "D".

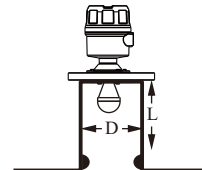

2. Radar installation should not be too close to the drum wall, avoid the drum wall attachment material reflection interference.

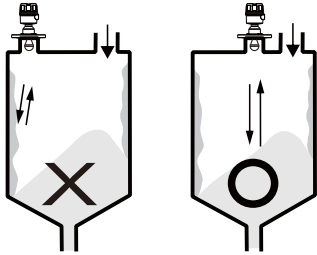

3. Radar installation not too close to the drum bracket to avoid reflection is incorrect

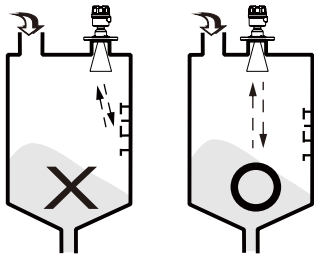

4. When obstructions inside the tank, tank be fitted with effectors, steer clear of the error echo reflected to the receiver, causing radar miscalculation.

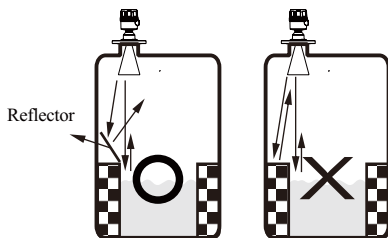

5. Outdoor installation should take shade or rain-proof measures.

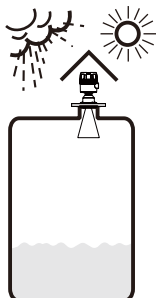

6. If drum internal agitator will have a strong vortex and foam, drum must increase waveguide, the upper waveguide drill vent holes to ensure the correctness of the measured value.

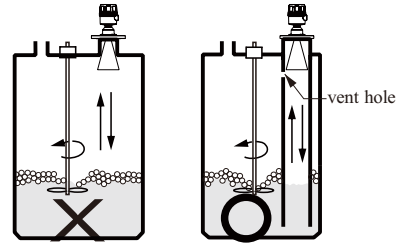

7. Installation should be avoided in the feed inlet position, avoid material interference or obstacles interference.

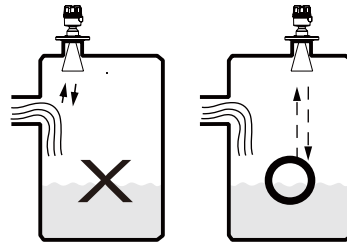

8. Installation should be avoided in the top center of the arch or round barrel will cause multiple echo reflections.

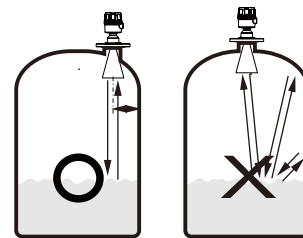

ORDER INFORMATION

JFR 2 0 0 0 0 - ⁰⁹ ¹⁰ ¹¹ ¹² ¹³ ¹⁴ ¹⁵ ¹⁶ ¹⁷ ¹⁸ ¹⁹ ²⁰ ²¹ ²² ²³

⑨⑩ Antenna type

- A1: Horn(43D)
- A2: Horn(100D/162L)
- A3: Horn(140D/270L)
- A4: Lens(43DS)
- A5: Lens(56D)
- B1: Horn(100D/126L)
- B2: Horn(140D/202L)

⑪⑫ Antenna material

- MA: SUS 304
- MB: SUS 316
- MC: SUS 316L
- 21: PTFE coating

Connection

⑬⑭	⑮⑯	⑰⑱
Flange	B1: 1-1/2"	03: PF male
AK: JIS-FF	B2: 2"	07: NPT male
AN: ANSI-RF	B4: 2-1/2"	40: 5 kg/cm ²
AS: DIN-FF	B5: 3"	42: 10 kg/cm ²
	B7: 4"	48: 150 Lbs
Thread	B8: 5"	49: 300 Lbs
AA: JIS	B9: 6"	57: PN10
AC: ANSI	E3: DN65	58: PN16
	E4: DN80	59: PN25
		60: PN16

※ (1) JFR-202,204 thread connection 1-1/2" PF only
 (2) JFR-212,214 thread connection 2" PF, NPT only
 (3) JFR-222,224 thread connection 2" PF only
 (4) JFR 234,232 thread connection 2"PF only
 (5) JFR 234,232 thread connection 1-1/2"NPT only
 (6) Please do check Radar antenna can be direct fitted in flange connection and nozzle below is the suggestion
 (7) 2"Flang is applicable in open area

Type	Opening	Flange size
JFR-21X	56mm	2-1/2"
JFR-22X	100mm	4"
JFR-23X	140mm	6"
JFR-24X	44mm	2"



JFR 2 0 0 0 0 -

09	10	11	12	13	14	15	16	17	18	19	20	21	22	23

⑱⑳ **Flange material**

- MA: SUS 304
- MB: SUS 316
- MC: SUS 316L
- MD: SS41 zinc coating
- 18: PP
- 21: PTFE
- 00: None

㉑ **Output**

- A: Loop Power 24 Vdc with HART
- B: 4-Wire 24Vdc 4~20mA with RS-485
- C: Loop Power 24 Vdc, 4~20mA

㉒ **Accuracy**

- A: ± 3mm
- B: ± 5mm
- C: ± 10mm
- D: ± 20mm
- ※2 Wire only option A: ± 5mm or C: ± 10mm

㉓ **Measuring distance**

- A: 10m
- B: 20m
- C: 30m
- D: 40m
- E: 70m

JFR Radar Level Transmitter

Customer Information

Prepared by: _____ Date: _____

Company: _____ Industry: _____

E-mail: _____ Phone Number: _____

Address: _____

Application Information

B.1 Measuring Material Information

Application Description:

Installation Area:	<input type="checkbox"/> Storage tank	<input type="checkbox"/> Process tank	<input type="checkbox"/> Open-air application	
Material Status :	<input type="checkbox"/> Liquid	<input type="checkbox"/> Slurry/ Sludge/ Paste	<input type="checkbox"/> Solid/ Granulate/Grain	<input type="checkbox"/> Powder
Material Name :		Dielectric Constant	<input type="checkbox"/> 1.4~1.9	<input type="checkbox"/> 4.0~10.0
			<input type="checkbox"/> 2.0~2.5	<input type="checkbox"/> > 10
			<input type="checkbox"/> 2.6~4.0	<input type="checkbox"/> Unknow

B.2 Power Supply

DC : _____ AC : _____

B.3 Output Signal

Analog : 4~20 mA-4 Wire 4~20mA 2-Wire

Digital : RS-485 HART Other

B.4 Measuring range

Measuring range: _____ meters

B.5 Measuring Condition

Operating Temperature

Max: _____ °C Min: _____ °C

Ambient Temperature

Max: _____ °C Min: _____ °C

Operating Pressure

Max: _____ Bar Min: _____ Bar

B.6 Connection



Connection: Threaded

Flange

Size and Standard: _____

Flange Material: _____

B.7 Tank Information

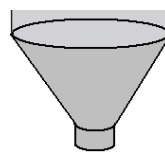
Tank Shape	<input type="checkbox"/> Vertical Cylinder	<input type="checkbox"/> Horizontal Cylinder	<input type="checkbox"/> Spherical
	<input type="checkbox"/> Cubical/rectangular <input type="checkbox"/> Other: _____		
Tank Material	<input type="checkbox"/> Cubical	<input type="checkbox"/> Plastic	<input type="checkbox"/> Cement <input type="checkbox"/> Other _____
Tank Bottom	<input type="checkbox"/> Metal		
	<input type="checkbox"/> Plastic		
	<input type="checkbox"/> Cement		
	<input type="checkbox"/> Other	_____	

Tank
 Tank Height (H): _____ m
 Tank Diameter (W): _____ m
 Cone Height (H1): _____ m
 (Ignore cone height with flat/disk bottom)

Radar
 Distance to tank wall(D1): _____ m

Nozzle
 Yes
 Nozzle Diameter (L): _____ m
 Nozzle Height (D): _____ m
 NO

Ladder
 Yes
 Distance to rada (D3): _____ m
 NO

Heater
 Yes
 NO

Other Internal Obstacles
 Yes
 NO

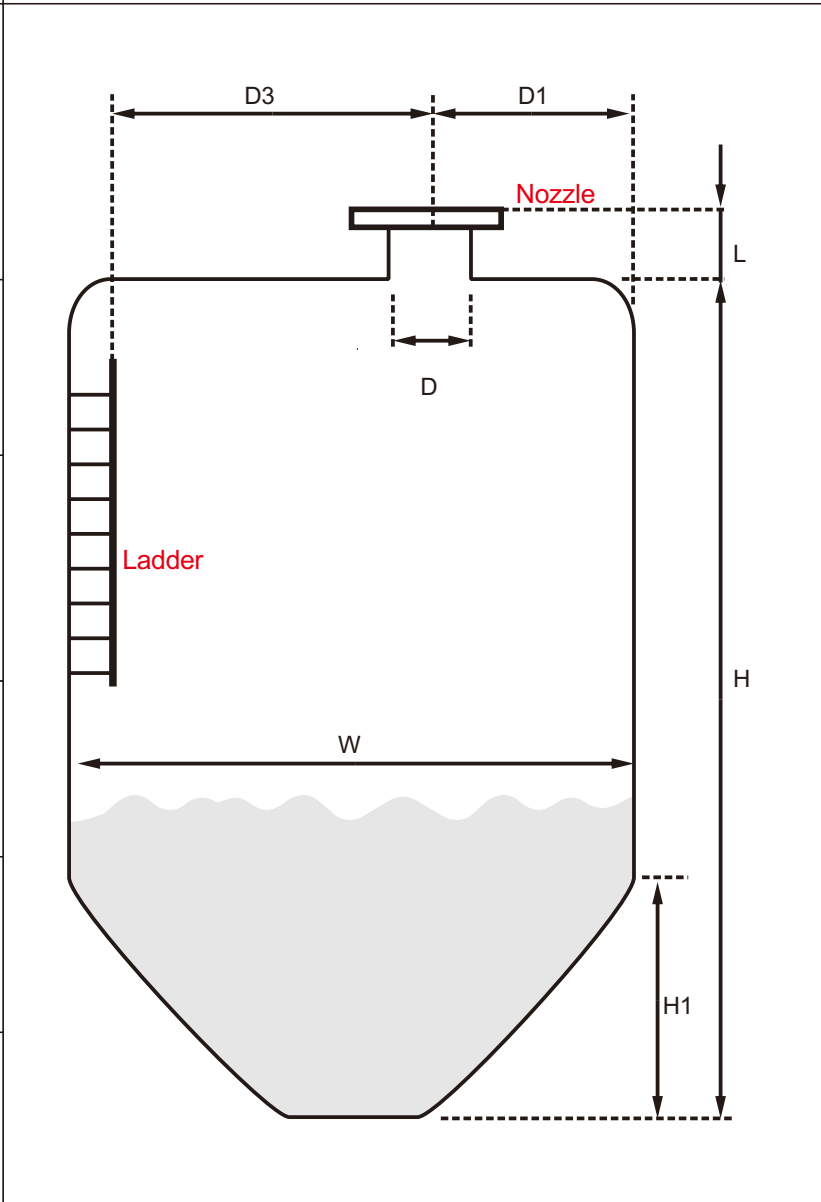

實蹟說明

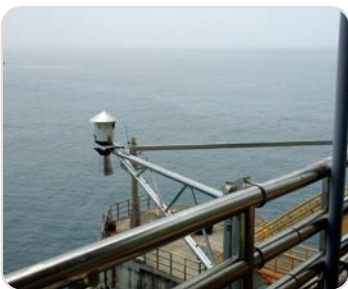

Power plant
port wave height edtection



Oil Factory
Process Oil Detection



Government agencies
flood prevention and control



Pharmaceutical Factory
Boiler Liquid Detection



Feed industry
butter storage detection



Oil Factory
Soybean oil level detection

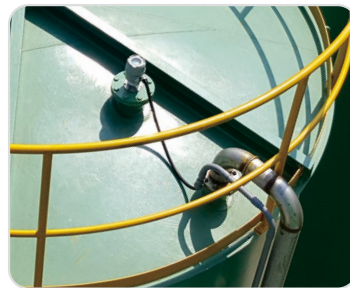

Plastic industry
chemical detection



Feeding plant
Corn storage tank detection

Global Network

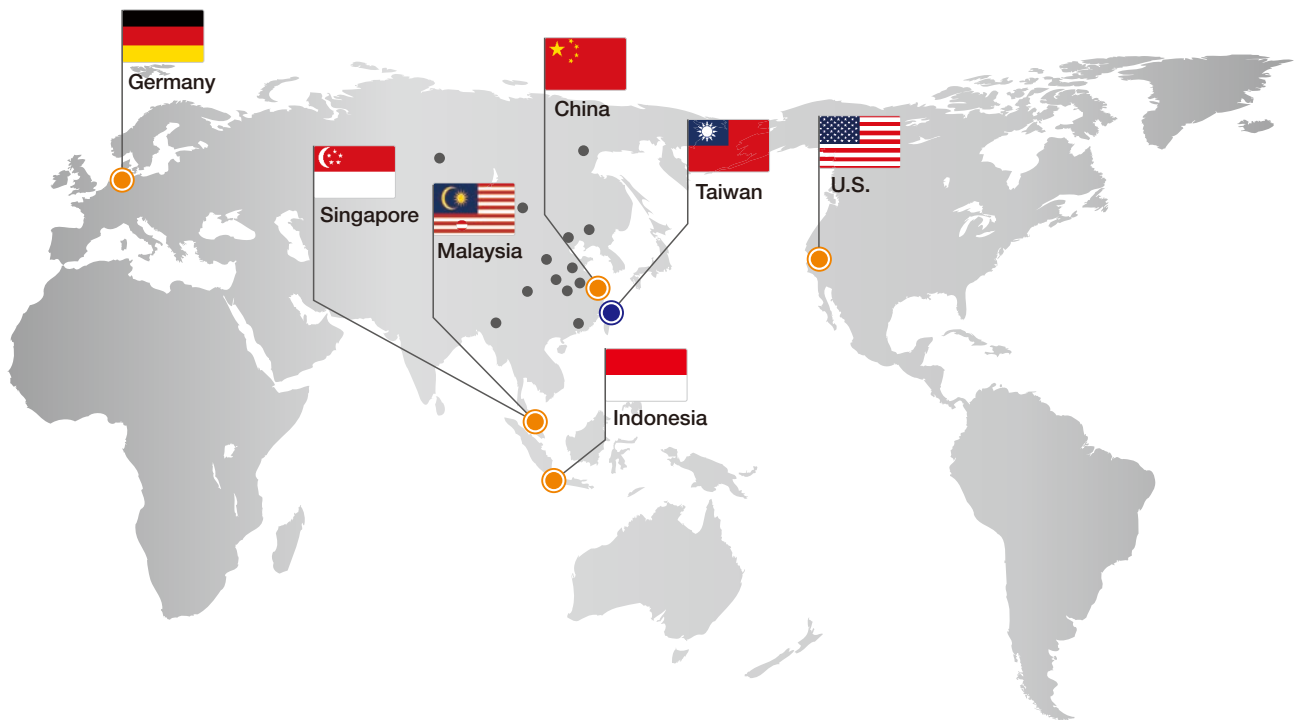

■ Asia

● Taiwan

FineTek Co., Ltd. - Taipei Head Quarter

No.16, Tzuchiang St., Tucheng Industrial Park
New Taipei City 236, Taiwan
TEL: 886-2-2269-6789
FAX: 886-2-2268-6682
EMAIL: info@fine-tek.com

● China

Fine automation Co., Ltd. - Shanghai Factory

No.451 DuHui Rd, MinHang District, Shanghai,
China 201109
TEL: 86-21-6490-7260
EMAIL: info.sh@fine-tek.com

● Singapore

FineTek Pte Ltd. - Singapore Office

No. 60 Kaki Bukit Place, #07-06 Eunos
Techpark 2 Lobby B, Singapore 415979
TEL: 65-6452-6340
EMAIL: info.sg@fine-tek.com

● Indonesia

FineTek Co., Ltd. - Indonesia Office

Ruko Golden 8 Blok H No.38
Gading Serpong, Tangerang, Indonesia
TEL: 62 (021)-2923-1688
EMAIL: info.id@fine-tek.com

● Malaysia

FineTek Co., Ltd. - Malaysia Office

8-05, Plaza Azalea, Persiaran Bandaraya,
Seksyen 14, 40000 Shah Alam, Selangor, Malaysia
TEL: 603-5524-7168
EMAIL: info.my@fine-tek.com

■ North America

● California, U.S.

Aplus Finetek Sensor Inc. - US Office

355 S. Lemon Ave, Suite D, Walnut,
CA 91789
TEL: 1 909 598 2488
FAX: 1 909 598 3188
EMAIL: info@aplusfine.com

■ Europe

● Germany

FineTek GmbH - Germany Office

Bei den Kämpen 26
21220 Seevetal-Ramelsloh, Germany
TEL: +49-(0)4185-8083-12
FAX: +49-(0)4185-8083-80
EMAIL: info@fine-tek.de

● Mütec Instruments GmbH - Germany Office

Bei den Kämpen 26
21220 Seevetal-Ramelsloh, Germany
TEL: +49-(0)4185-8083-0
FAX: +49-(0)4185-8083-80
EMAIL: muetec@muetec.de



Distributor: